

L1 BL.3A  
 L2 BL.3A  
 L3 BL.3A  
 N BL.3A

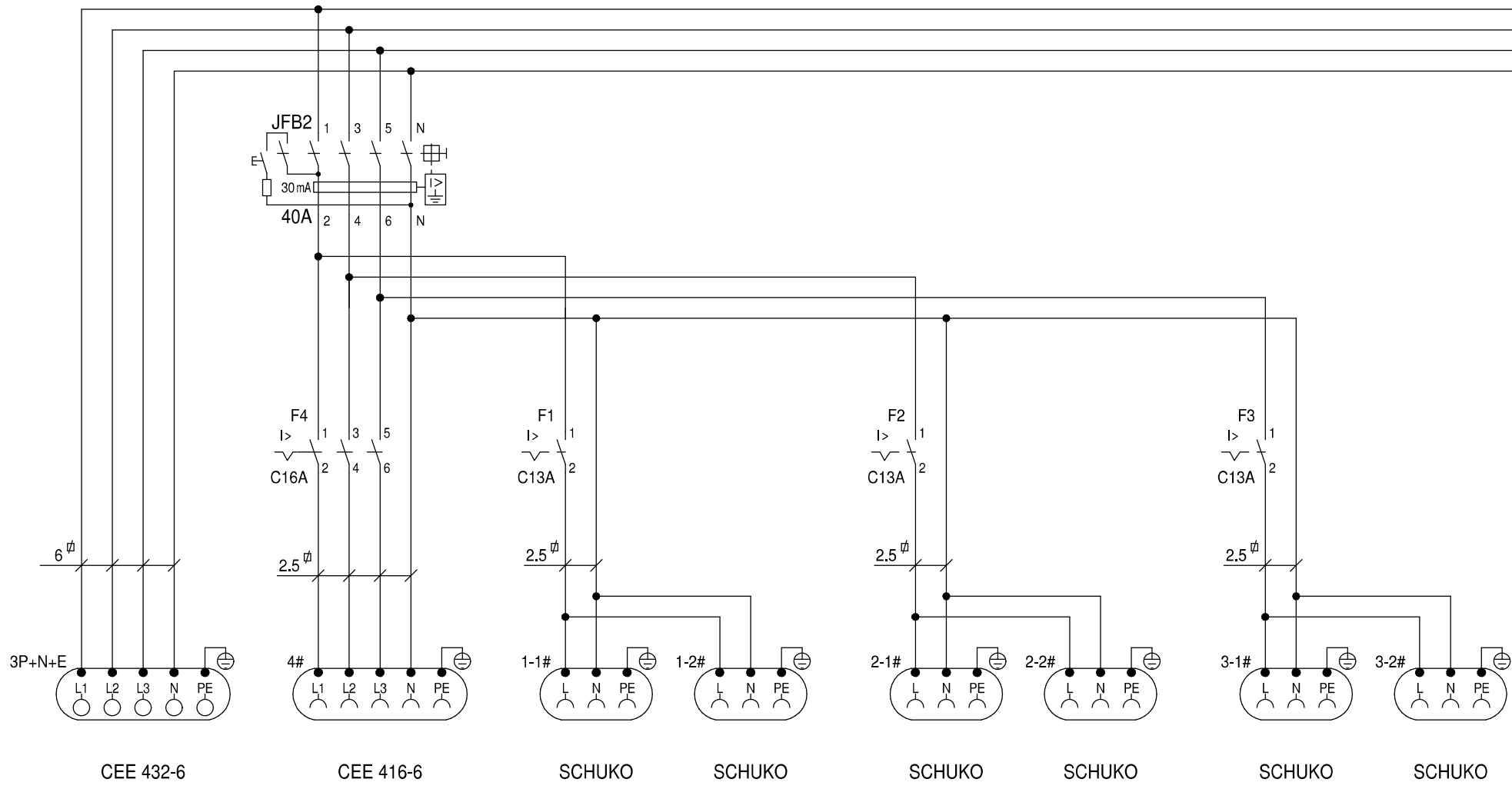

| REV | DATUM | AVSER |
|-----|-------|-------|
|     |       |       |

**HOLTE**  
 SWEDEN

HOLTE Sweden AB  
 Julius Väg 1  
 331 41 Värnamo info@holtesweden.se

|                                |                        |  |
|--------------------------------|------------------------|--|
| DATUM<br>2022-12-12            | ARTIKELNUMMER<br>25070 | BETECKNING<br>Undercentral 32A UC32-00136-03 |
| Undercentral 32A UC32-00136-03 |                        | RITAD  |
|                                |                        | PROJEKTÖR                                    |
| UTGÅVA<br>A*                   | NÄSTA BLAD<br>3        | BLAD<br>2                                    |

BL.2K L1  
 BL.2K L2  
 BL.2K L3  
 BL.2K N

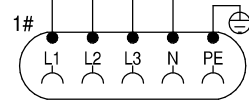
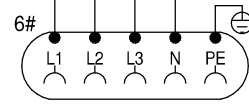
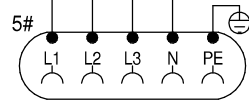
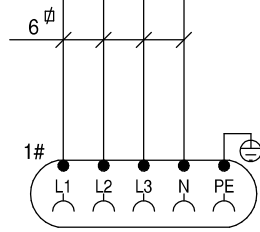
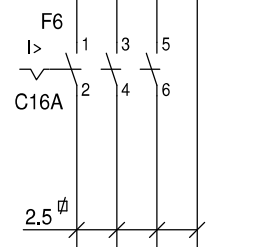
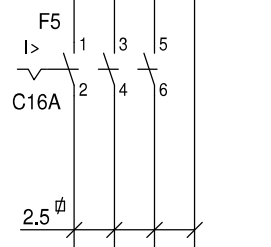
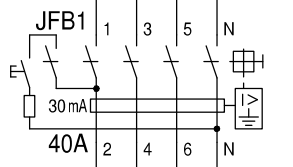
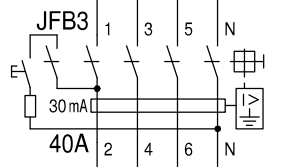

CEE 416-6

CEE 416-6

CEE 432-6

| REV | DATUM | AVSER |
|-----|-------|-------|
|     |       |       |

**HOLTE**  
 SWEDEN

HOLTE Sweden AB  
 Julius Väg 1  
 331 41 Värnamo info@holtesweden.se

| DATUM                          | ARTIKELNUMMER | BETECKNING                     |
|--------------------------------|---------------|--------------------------------|
| 2022-12-12                     | 25070         | Undercentral 32A UC32-00136-03 |
| Undercentral 32A UC32-00136-03 |               | RITAD                          |
|                                |               | PROJEKTÖR                      |
|                                |               | UTGÅVA                         |
|                                |               | NÄSTA BLAD                     |
|                                |               | BLAD                           |
|                                |               | A*                             |
|                                |               | 3                              |